

© British Standards Institution. No part of this publication may be photocopied or otherwise reproduced without the prior permission in writing of BSI

British Standard

Fire tests on building materials and structures

Part 24. Method for determination of the fire resistance of ventilation ducts

[ISO title : Fire resistance tests – Ventilation ducts]

Essais au feu des matériaux et structures du bâtiment

Partie 24. Méthode de détermination de la résistance au feu des conduits de ventilation

Brandschutztechnische Prüfungen an Baustoffen und Bauten

Teil 24. Verfahren zur Bestimmung des Feuerwiderstandes von Lüftungskanälen

Contents

	Page		Page
National foreword	Inside front cover	Table	
Committees responsible	Back cover	Fire resistance test on ventilation ducts – Necessary measurements	19
Method		Figures	
0 Introduction	1	1 Test arrangement for vertical ducts	7
1 Scope and field of application	1	2 Test arrangement for horizontal ducts	8
2 Reference	1	3 Test arrangement for measuring restraint force for horizontal ducts at the furnace penetration point	9
3 Principle	2	4 Location of furnace thermocouples for ducts in vertical position	10
4 Apparatus	2	5 Location of furnace thermocouples for ducts in horizontal position	11
5 Test conditions	2	6 Location of thermocouples on vertical ducts outside the furnace	12
6 Preparation of test specimens	3	7 Location of thermocouples on horizontal ducts outside the furnace	13
7 Test arrangements	3	8 Restraint of duct outside the furnace	14
8 Procedure	4		
9 Performance criteria for expression of fire resistance	5		
10 Test report	6		
Annexes			
Explanatory notes	15		

National foreword

This Part of BS 476 has been prepared under the direction of the Fire Standards Committee. It is identical with ISO 6944-1985 'Fire resistance tests – Ventilation ducts' published by the International Organization for Standardization (ISO).

Terminology and conventions. The text of the international standard has been approved as suitable for publication as a British Standard without deviation. Some terminology and certain conventions are not identical with those used in British Standards; attention is drawn especially to the following.

The comma has been used as a decimal marker. In British Standards it is current practice to use a full point on the baseline as the decimal marker.

Wherever the words 'International Standard' appear, referring to this standard, they should be read as 'Part of BS 476'.

Cross-references. The Technical Committee has reviewed the provisions of ISO 834-1975, to which reference is made in the text, and has decided that they are acceptable for use in conjunction with this standard. A related British Standard to ISO 834 is BS 476 : Part 20.

Compliance with a British Standard does not of itself confer immunity from legal obligations.

British Standard

Fire tests on building materials and structures

Part 24. Method for determination of the fire resistance of ventilation ducts

0 Introduction

This International Standard has been prepared because a fire resistance test for ventilation ducts has become necessary in order to permit evaluation of ducts designed to prevent fire spread across fire barriers in the absence of fire dampers. It should be read in conjunction with ISO 834.

The annex provides explanatory notes which give important background information, but it does not constitute a mandatory part of this International Standard.

SAFETY WARNING — So that suitable precautions may be taken to safeguard health, the attention of all concerned in fire tests is drawn to the possibility that toxic or harmful gases may be evolved during the combustion of test specimens.

1 Scope and field of application

1.1 This International Standard specifies a method of test and criteria for the determination of the fire resistance of vertical and horizontal ventilation ducts under standardized fire conditions

1.2 The general purpose of this test is to measure the ability of a representative duct or duct assembly to resist the spread of fire from one fire compartment to another without the aid of fire dampers.

1.3 It is applicable to vertical and horizontal ducts, with or without branches, taking into account joints, air supply and exhaust openings, as well as suspension devices, etc

1.4 This International Standard is not applicable to

- a) ducts above fire-resisting suspended ceilings (horizontal membranes) in those cases where the ducts rely for their fire resistance on the performance of the ceiling;

NOTE — Other tests are necessary for these ducts

- b) ducts containing fire dampers at points where they pass through fire separations.

NOTE — In order to assess the fire resistance of fire dampers, other tests are required. A method of test for fire dampers is under consideration as a subject for a future International Standard

1.5 This International Standard is not appropriate for the following ducts unless the further criteria described in the annex are established to the satisfaction of the appropriate authority:

- a) ducts of materials which are extremely sensitive to thermal shock;

NOTE — Thermal shock may affect such ducts in a way that would differ from the effect in this test, but the test may still be used where it can be established that sensitivity to thermal shock is within acceptable limits

- b) smoke outlet ducts;

NOTE — These ducts need to retain their integrity and cross-sectional area under fire conditions. Consequently criteria for acceptance additional to those given in this International Standard are required. This International Standard is only applicable, therefore, to smoke outlet ducts if the criteria for integrity failure of a representative smoke outlet duct within the furnace and the loss of retention of cross-sectional area of such ducts are agreed between all parties concerned and are investigated and reported (see the annex).

- c) ducts lined on the inside with combustible material or which in practice may accumulate combustible deposits on their inside face (such as kitchen extract ducts)

NOTE — Additional criteria regarding the insulation performance of the duct are required in this case (see the annex)

1.6 This International Standard does not take into consideration the effect of impact shock loading on ducts due to the collapse of supporting or adjacent structural members or other components, or of impact- or thermal shock loading resulting from the application of a water (hose) stream.

NOTE — The method described in this International Standard should be used solely to measure and describe the properties of ducts and their supports in response to heat and flame under controlled laboratory conditions and should not by itself be considered or used for the description, appraisal or regulation of the fire hazard of such ducts or supports under actual fire conditions.

2 Reference

ISO 834, *Fire-resistance tests — Elements of building construction*.

3 Principle

3.1 The test consists of measurement of the length of time for which test specimens, of specified dimensions, satisfy specified criteria under prescribed conditions during the period of exposure to fire.

3.2 If a rigid restraint is not provided (see 7.2.9), measurements shall be made of any elongation or shortening of the duct which occurs during the test, in order to provide an indication of allowances for elongation or shortening which are to be made in the design of the duct system in practice

3.3 The following measurements are optional and are not to be considered an integral part of this test method.

a) gas leakage rates, to provide an indication of the potential smoke leakage through the duct;

b) the release of smoke from the unexposed face, to provide an indication of smoke generated by duct covering and lining materials;

c) restraint forces at the penetration point in the furnace wall opposing horizontal expansion of the ducts, to provide an indication of potential structural failure of lightweight partitions through which the ducts may pass; however, if the duct specimen at the penetration point is fire-stopped with mineral wool or other flexible fire-stopping, there will not be any full restraint at this point (see 7.2.9 and the annex), and if the duct is restrained outside the furnace (see 7.2.9), it will not be appropriate to measure restraint forces at the penetration point.

3.4 The test takes into account the effect of fire exposure from the outside as well as the effect of fire entering the ducts in conditions where forced air movement may or may not be present

3.5 The test specimens incorporate the usual joints and exhaust openings and are suspended as they would be in practice. The specimens are supplied with air in a manner which is indicative of the "fan off" and "fan on" situations which could arise in practice.

As the load-bearing capacity of suspension or fixing devices is often critical in a fire, additional separate evaluation of these devices is required. This evaluation may be carried out in a separate furnace. For the suspension and fixing devices, the evaluation procedure may be separated into parts, such as tests for the device for fastening to the floor, ceiling or wall, tests for the device for fastening to the duct and tests for the hangers. After having chosen the correct fastening device and hanger, the complete assembly can be evaluated

3.6 If specified by the sponsor, part of the test may be omitted if the duct concerned is not required, in practice, to meet all the conditions envisaged by the test, for example a duct designed for use only in the vertical position need not be tested in the horizontal position. Any such deviations from the full test procedure shall be clearly described in the test report

4 Apparatus

The main items of apparatus are as follows

4.1 Furnace, capable of subjecting a ventilation duct to the standard heating and pressure conditions specified in clause 5, suitable for testing ducts in the vertical (see figure 1) or horizontal (see figure 2) position.

4.2 Device, if applicable (see 3.3), fixed to the furnace wall, for measuring the forces which restrain thermal elongation in horizontal ducts. A test arrangement for this purpose is shown in figure 3. Details are described in the annex.

4.3 Thermocouples, for measuring the internal temperature of the furnace and internal and external temperatures of the test specimens in conformity with the requirements given in 5.1.2, 5.1.3 and 5.1.4 and, if necessary, a movable thermocouple (see 8.3.1.2)

4.4 Equipment for measuring gas pressures in the furnace and in the ducts

4.5 Fan, for extracting gas from ducts B in figures 1 and 2 with a suction capacity of at least $2 \times V_n$ (required capacity: $V_n = 3 \text{ m/s} \times 1 \text{ m} \times 0,25 \text{ m} = 0,75 \text{ m}^3/\text{s}$), i.e. sufficient to produce an air velocity in the ducts of at least 3 m/s, measured at ambient temperature before the test.

The characteristic curve of the fan shall be horizontal for the actual air flow. The capacity of the fan shall not change by more than 10 % in the event of a drop in pressure of up to 50 Pa.

NOTE — The regulation of the gas flow can be arranged by a flow rate controller, installed just before the fan. This provides a sufficient gas flow even when deformations of the duct reducing its cross-sectional area by not more than 25 % occur. The case where the duct collapses in such a way that its cross-sectional area is reduced by more than 25 % can be disregarded in determining the fan capacity because, before this happens, a stability failure or an integrity failure at the fire-stopping would have already occurred

For horizontal ducts, a second fan is required to produce and maintain an underpressure of 300 Pa in duct A (see figure 2)

5 Test conditions

5.1 Fire exposure

5.1.1 Temperature rise

The temperature rise shall be controlled in accordance with ISO 834, subclause 4.1.1.

5.1.2 Measurement of furnace temperature

The furnace temperature shall be measured in accordance with ISO 834, subclause 4.1.2.

The positions of the thermocouples shall be as shown in figures 4 and 5.

5.1.3 Tolerances

Tolerances shall be assessed in accordance with ISO 834, subclause 4.1.3

5.1.4 Measurement of temperature of test specimens

The temperature of the test specimens shall be measured in accordance with ISO 834, subclause 4.1.4.

The positions of the thermocouples shall be as shown in figures 6 and 7.¹⁾ Thermocouples for estimating average temperature shall be placed in such a way as to give information representative of the normal heat transfer through the walls of the ducts

5.1.5 Measurement of temperatures of flue gases

The gas temperatures inside the ducts shall be measured at the locations shown in figures 6 and 7. The hot junctions of the thermocouples shall be placed centrally in the ducts and at the centre of the top edge of the opening in the vertical duct A (see figure 6). Further details are given in ISO 834, subclause 4.1.2.3

5.2 Pressure conditions

The furnace pressure shall be maintained according to ISO 834, subclause 4.2.

The neutral plane shall be below the horizontal specimen. The pressure inside horizontal duct A (see figure 2) shall be 300 ± 10 Pa below the ambient (laboratory) pressure at the beginning of the test, and during the test the fan setting shall not be altered. The underpressure shall be continuously recorded to provide a measure of air leakage.

5.3 Air velocity

The air velocity in duct B (see figures 1 and 2) shall be 3 m/s measured at ambient temperature at the start of the test and thereafter the fan velocity shall not be readjusted. The measuring point shall be located inside the tube connecting the test specimen to the fan. The measurements shall then be corrected by the ratio of the cross-sectional areas.

6 Preparation of test specimens

6.1 Dimensions

6.1.1 The test specimens shall normally be full size

6.1.2 If compliance with the requirements of 6.1.1 is not possible, the following shall be the minimum dimensions of the parts of test specimen exposed:

a) in the furnace (see figures 1 and 2 and clause A 5):

- | | |
|---------------------|---------------|
| 1) horizontal ducts | length 3,0 m, |
| 2) vertical ducts: | length 2,0 m, |

b) outside the furnace:

- | | |
|---------------------|---------------|
| 1) horizontal ducts | length 2,5 m, |
| 2) vertical ducts: | length 2,0 m. |

6.1.3 If applicable, specimens having a ratio of shortest side to longest side of 1/4 shall be tested. The longest side shall be 1 m or as near to 1 m as the dimensions of the furnace allow (see the annex).

6.2 Conditioning

Test specimens containing hygroscopic materials, or other materials which can be affected by moisture, shall be conditioned to equilibrium with the prevailing conditions in the laboratory, which shall be within the following limits:

- temperature (dry bulb): 25 ± 15 °C,
- relative humidity: 40 to 65 %.

7 Test arrangements

7.1 Details of test specimens

The test shall be made on a test specimen representative of the complete duct assembly, including integral or intended insulation, on which information is required. Each type of duct requires a different approach and an attempt shall be made to reproduce the boundary conditions and the method of fixing or support inside and outside the furnace representative of that used in practice.

The fire-stopping shall be as used in practice following established manuals of good practice for field installation, and shall be specified by the manufacturer. If the width of the gap for fire-stopping around the duct at the furnace penetration point is not specified, a width of 20 mm shall be used

The furnace wall which is penetrated by duct B (see figure 2) shall, for a distance all round the duct of at least 300 mm, be constructed of lightweight concrete blocks not more than 100 mm thick or shall have a similar lightweight construction having a level of fire resistance appropriate to the duct being tested

7.2 Duct arrangement

7.2.1 A single duct may be tested in the furnace, or alternatively, two or more ducts may be tested in the same furnace, provided that there is sufficient space to do so, in accordance with the dimensions shown in figures 1 and 2.

1) Additional bare wire thermocouples may be placed on supports or in other positions on the ducts to obtain additional data for use in assessments

7.2.2 Ducts shall be arranged as in practice (see figures 1 and 2) Both horizontal ducts shall abut against the furnace wall at one end and shall penetrate the furnace wall at the other. Both the end of the horizontal duct A (see figure 2) within the furnace and the end of the branch duct attached thereto shall be closed independently of any furnace enclosure by materials and construction similar to the remainder of the duct.

7.2.3 Vertical ducts (see figure 1) shall be tested standing on the furnace floor and penetrating the furnace roof slab; the ducts shall be fixed at the furnace roof level as they would be fixed in practice when penetrating a floor

7.2.4 For horizontal ducts, the test arrangement shall include at least two joints inside the furnace and at least one joint outside it One joint shall be at the centre of the span between the supports both inside and outside the furnace, if this is possible in practice.

7.2.5 For vertical ducts, the test arrangement shall include at least one joint inside and one joint outside the furnace (see figure 1).

7.2.6 The openings of all ducts shall have an area which is at least half the cross-sectional area of the ducts Such openings shall be in the positions shown in figures 1 and 2.

7.2.7 The horizontal duct A (see figure 2) shall include one sharp bend of the same cross-sectional area as the main duct and a T-piece to form a short branch duct All specimens including this branch shall be mounted with the suspension or fixing devices as would be provided in practice.

7.2.8 There shall be a clearance of 500 ± 50 mm between the top of the horizontal duct and the ceiling, and also at least 500 mm between the underside of the horizontal duct and the floor. Similarly, there shall be a clearance of at least 500 mm between the sides of ducts and the furnace walls, except in the case of assemblies of ducts as shown in figures 1 and 2.

7.2.9 When, in practice, horizontal ducts and/or the applied fire protective insulation outside the fire compartment is likely to be subject to rigid restraint against elongation forces, either from building works (walls, etc.) against which the duct abuts, or where the rest of the duct assembly outside the fire compartment could afford such rigid restraint (such as may be afforded by ducts with short, rigid supports), full restraint shall be produced in the specimen at points $2\ 000 \pm 50$ mm from and outside the furnace enclosure

Such restraint shall be full in the direction of the duct, so as to resist all expansion forces in this direction, but there shall be no restraint (at ambient temperature) to movement in the vertical direction

In these cases, the measurement of restraint forces and elongations are not applicable. In other cases, the parts of specimens outside the furnace shall be unrestrained

7.3 Materials and workmanship

The materials and standard of workmanship of the test specimens shall be representative of good practice, as defined by national codes and standards

8 Procedure

8.1 Test conditions

Parts of ducts within the furnace shall normally be exposed to fire from all sides over their whole length Ducts shall only be exposed on less than four sides if this is likely to occur in practice Tests can be performed on assemblies of ducts (see figure 1) Alternatively, tests can be performed with a duct positioned close to a wall or floor if it is desired to represent this condition in practice.

8.2 Control of conditions to permit assessment of integrity

Twenty minutes after the start of the test, stop the fan in duct B (see figures 1 and 2) and, where it is intended to evaluate the "fire outside duct" situation with the duct only in the horizontal position (see 3.6), stop the fan in horizontal duct A (see figure 2) for about 5 min to enable an assessment of integrity of the duct assembly outside the furnace to be carried out under stable conditions in the "fan off" situation. Then start the fan in duct B and, where applicable, in horizontal duct A, and stop it for a 5 min period 10 min before the completion of every 30 min period of the test. Make assessments of integrity in the "fan on" situation at all other times.

8.3 Test measurements and observations

8.3.1 Assessment of fire resistance

Make the following measurements and observations to enable the criteria of stability, insulation and integrity (see clause 1) to be assessed.

8.3.1.1 Stability

Record the time when the suspension or fixing devices can no longer retain a duct in its intended position or when sections of the duct collapse.

8.3.1.2 Insulation (temperature of unexposed face)

Measure the average and maximum temperatures of the unexposed faces of the test specimens as specified in 5.1.4 and ISO 834, subclause 6.2.2.1, using a movable thermocouple to locate points of high temperature.

8.3.1.3 Integrity

- a) Record any cracks and openings which indicate loss of integrity.
- b) Determine the time at which the passage of flames or of hot gases outside the furnace occurs according to ISO 834,

subclause 6.2.3.1, the cotton pad being applied to the openings outside the duct, if provided, and to any crack or hole which develops.

c) Measure and record the temperature of the gases issuing from openings in the ducts outside the furnace and at penetration points inside the ducts. (See figures 6 and 7; thermocouples 1 and 2 are used.)

8.3.2 Restraint forces and thermal elongation or shortening

If applicable, measure and record the restraint force in duct B (see figure 2) at the penetration point [see 3.3 c)].

Measure and record the thermal elongation or shortening of ducts A (see figures 1 and 2) at the penetration point, where no rigid restraint is provided in accordance with 7.2.9

8.3.3 Additional observations

Throughout the test, make observations of all changes and occurrences which do not affect the performance criteria but which could create hazards in a building, including, for example:

- a) deflections;
- b) the emissions of smoke or noxious fumes from the unexposed face of a duct, for example attributable to its coverings and/or lining;
- c) a decrease in cross-sectional area of the ducts (in order to provide information on the ability of the ducts to serve as smoke extraction ducts).

8.4 Duration of the test

8.4.1 Normally, the test specimen shall be heated in the prescribed manner until failure occurs under any one of the relevant performance criteria, namely

- a) stability (see 9.2.1);
- b) insulation (see 9.2.2);
- c) integrity (see 9.2.3).

8.4.2 In tests other than those on test specimens judged only by the criterion of stability (see 9.2.1), testing may be continued after failure under either of the other two criteria (see 9.2.2 and 9.2.3) by prior agreement between the sponsor of the test and the testing authority, until failure occurs under the other criterion, provided that collapse of the specimen has not already occurred

8.4.3 Alternatively, the test may be concluded after a period determined by prior agreement between the sponsor and the testing authority, even if no failure under any of the criteria has occurred at the end of that period.

8.4.4 The length of time from the commencement of heating for which the test specimen complies with the relevant requirement(s) shall be expressed in minutes.

8.5 Calibration

The instrumentation used for measuring temperature, pressure, air velocity and force shall be calibrated, using established reference standards, and instrument readings shall be corrected as appropriate. Any measurement uncertainty shall be reported.

9 Performance criteria for expression of fire resistance

9.1 General

The fire resistance of test specimens shall be the duration, in minutes, of heating in accordance with 5.1.1 until failure occurs according to one or more of the performance criteria, i.e. stability, insulation, integrity, or until the test is terminated, whichever is the shortest time.

In expressing the test result, the words "stability", "insulation" and "integrity" shall be followed by the time expressed in minutes, denoting the period of successful compliance under each of these headings.

9.2 Performance criteria

9.2.1 Stability

Stability failure shall be deemed to have occurred in duct A within the furnace and in ducts A and B outside the furnace when the duct collapses in such a manner that the duct no longer fulfils its intended function.

9.2.2 Insulation

Insulation failure shall be deemed to have occurred when the temperature rise above initial ambient temperature in the laboratory on the unexposed surface of the test specimen outside the furnace exceeds either

- a) 140 °C as an average value (see 5.1.4); or
- b) 180 °C as a maximum value read by any surface thermocouple

NOTE — See also the annex, clause A.1.d) in respect of insulation failure of ducts A in figures 1 and 2 within the furnace where such ducts contain combustible materials, clause A.7.1, regarding the need for care in siting openings into ducts close to fire separation walls

9.2.3 Integrity

The presence and formation in the test specimen of cracks, holes or other openings outside the furnace through which flames or hot gases can pass shall constitute integrity failure

Integrity failure shall also be deemed to have occurred when the cotton pad referred to in ISO 834, subclause 6.2.3.1, is ignited

or when sustained flaming, of duration at least 10 s, appears on the unexposed face of the test specimen outside the furnace.

9.3 Precision and accuracy

No quantitative data for precision and accuracy are available at present

10 Test report

The test report shall include the following information:

- a) name of testing laboratory;
- b) name of sponsor;
- c) date of test,
- d) name of manufacturer and the trade name (if any) of the product;
- e) details of construction and conditioning of the test specimens, including detailed information on the relevant

physical and mechanical properties of the materials used, together with drawings illustrating the essential features and including the number of sides of the test specimens exposed to fire in the furnace (see 8.1);

f) whether the duct was considered restrained or unrestrained, including methods of fixing, support and mounting, as appropriate for the type of specimen, and a description of the method and materials used to seal the opening between the duct and cut-out provided in the wall to accommodate the duct;

g) the force (if measured) due to restraint at the furnace penetration point as a function of time, presented as a graph;

h) the thermal elongation or shortening (if measured) of ducts A in figures 1 and 2 (see 8.3.2);

j) other observations made during the test according to 8.3, including a complete record of measured temperatures as a function of time;

k) test results as required by clause 9. Where the test is terminated before the occurrence of failure under the relevant criteria, this shall be reported.

Section

Dimensions in millimetres

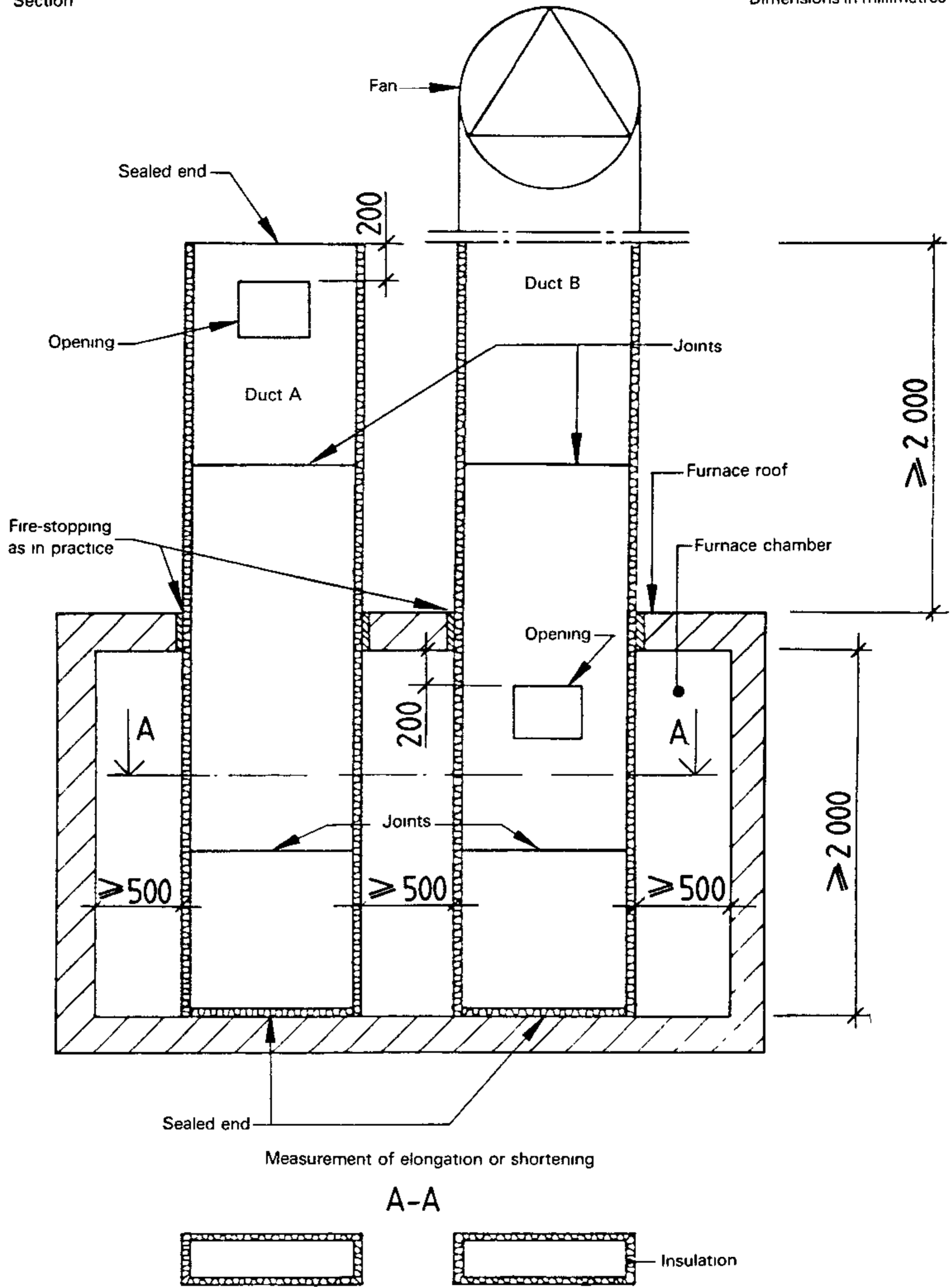
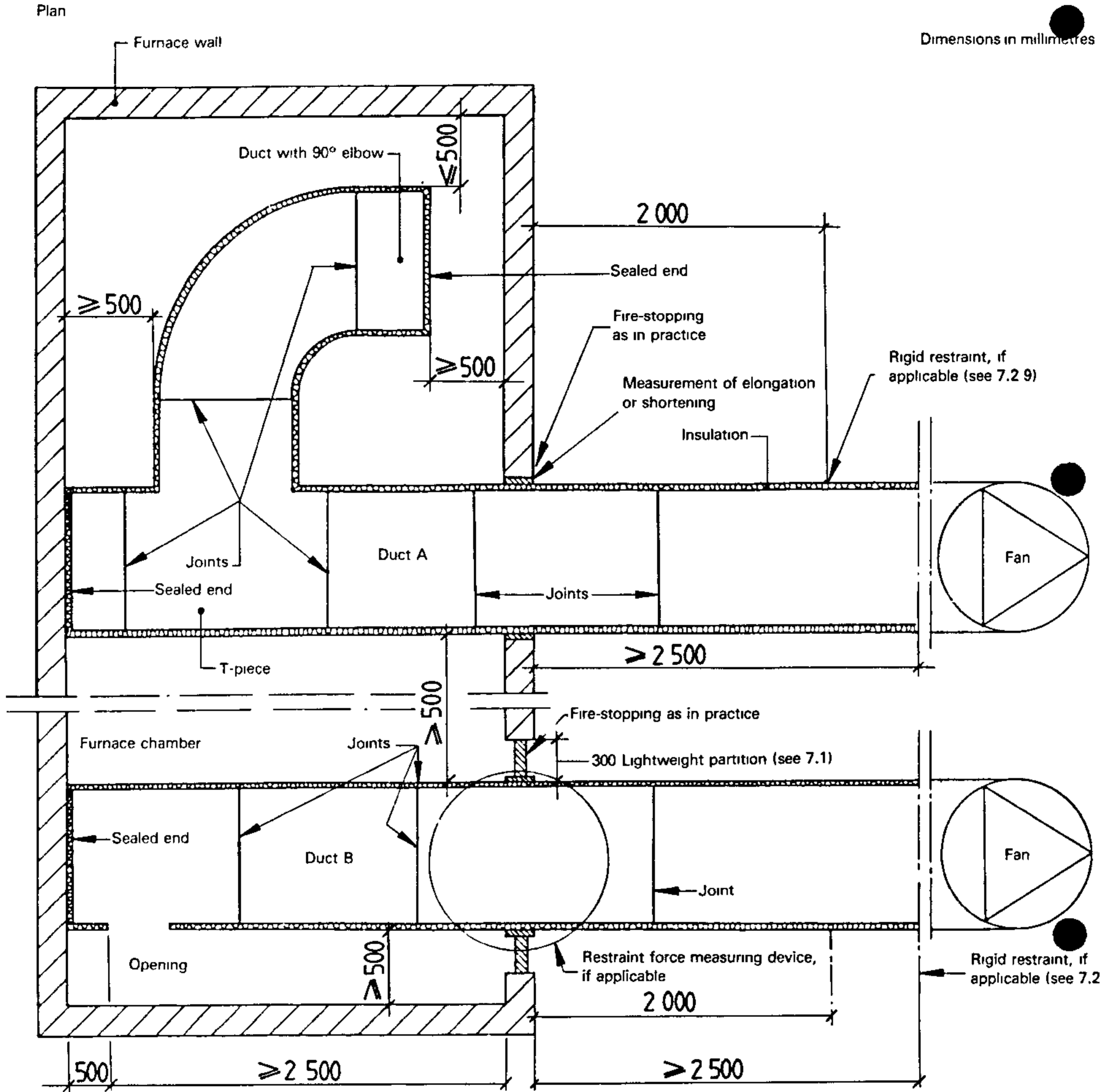

Figure 1 – Test arrangement for vertical ducts



NOTE — The sealed end shall be independent of the furnace wall

[See detail in figure 3 and 3.3 c) and 7.2.9]

Figure 2 — Test arrangement for horizontal ducts

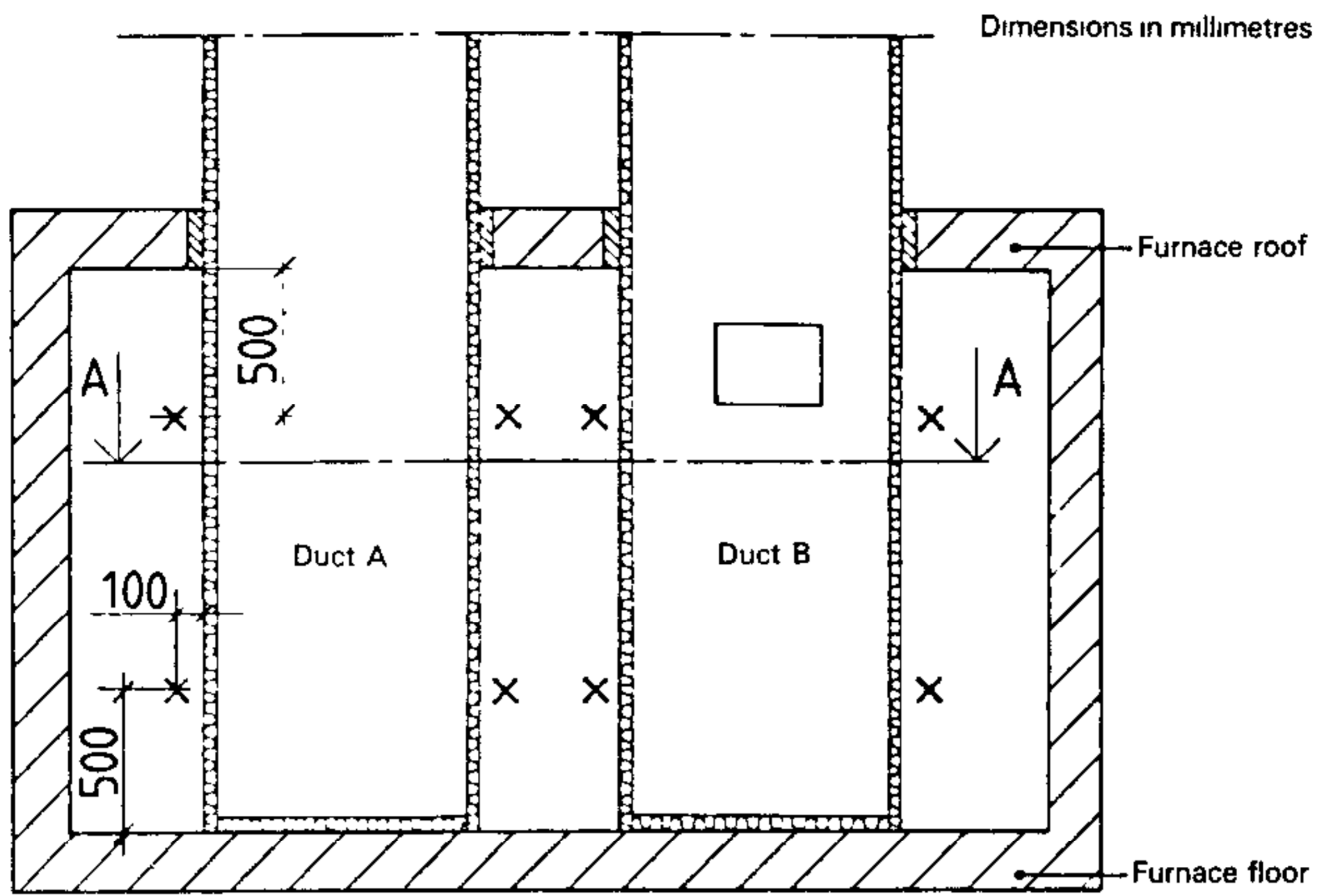

A - A

X = Thermocouples

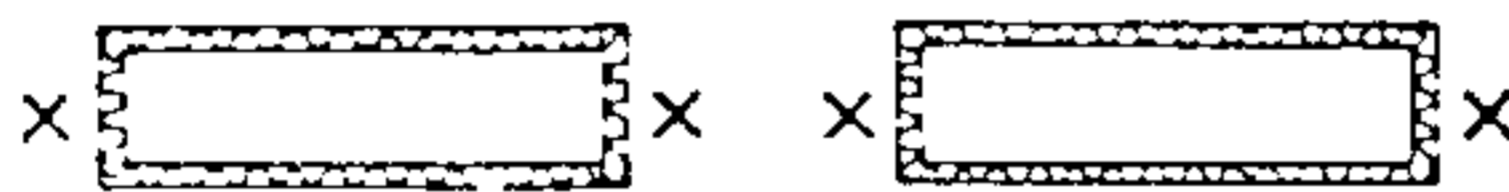

Alternative locations for assemblies of ducts

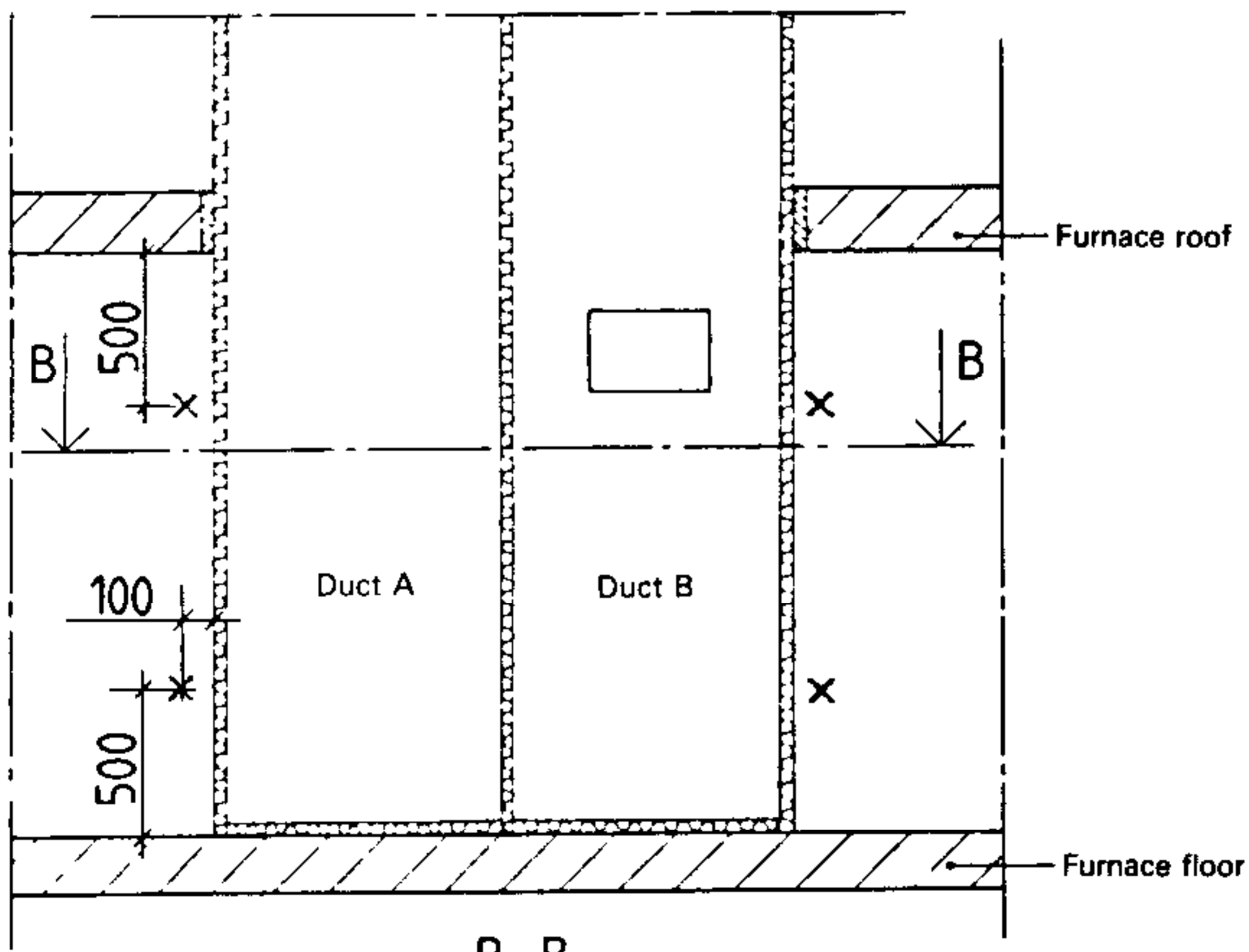

B - B

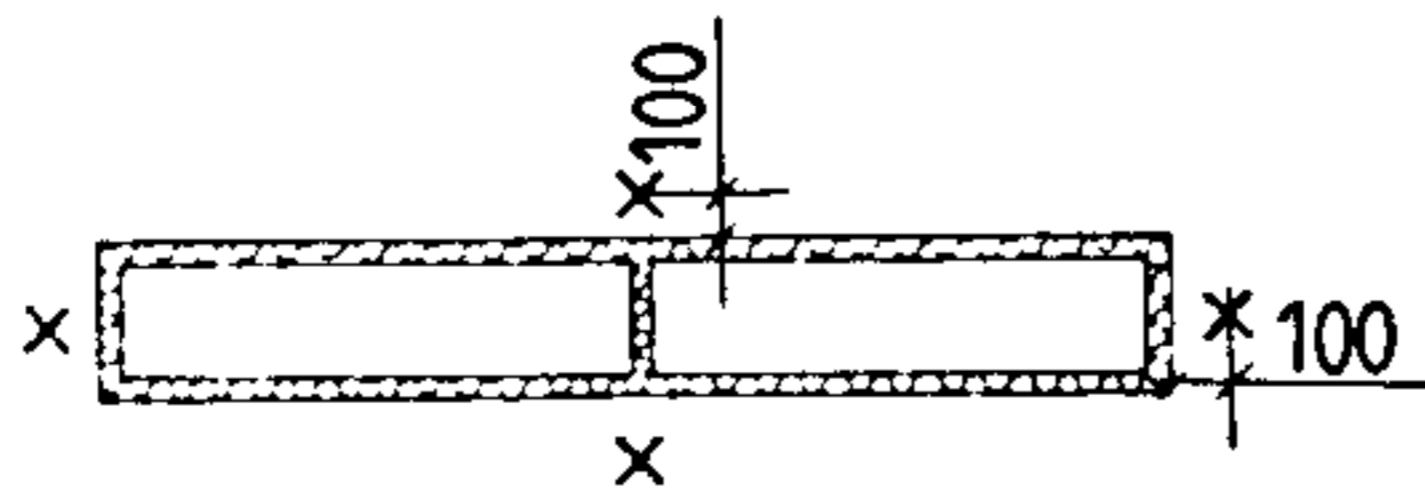

Figure 4 – Location of furnace thermocouples for ducts in vertical position (see also figure 1)

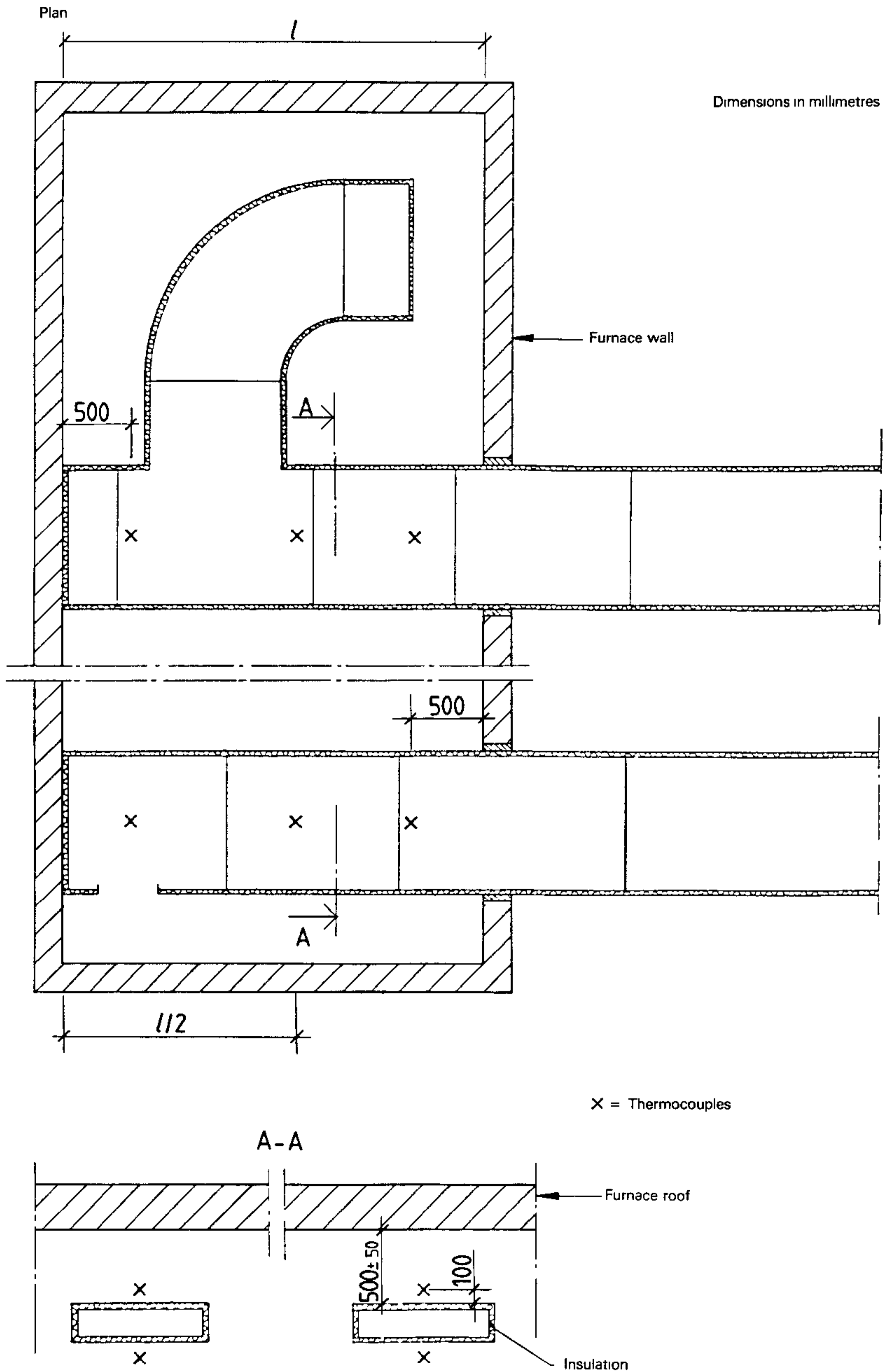
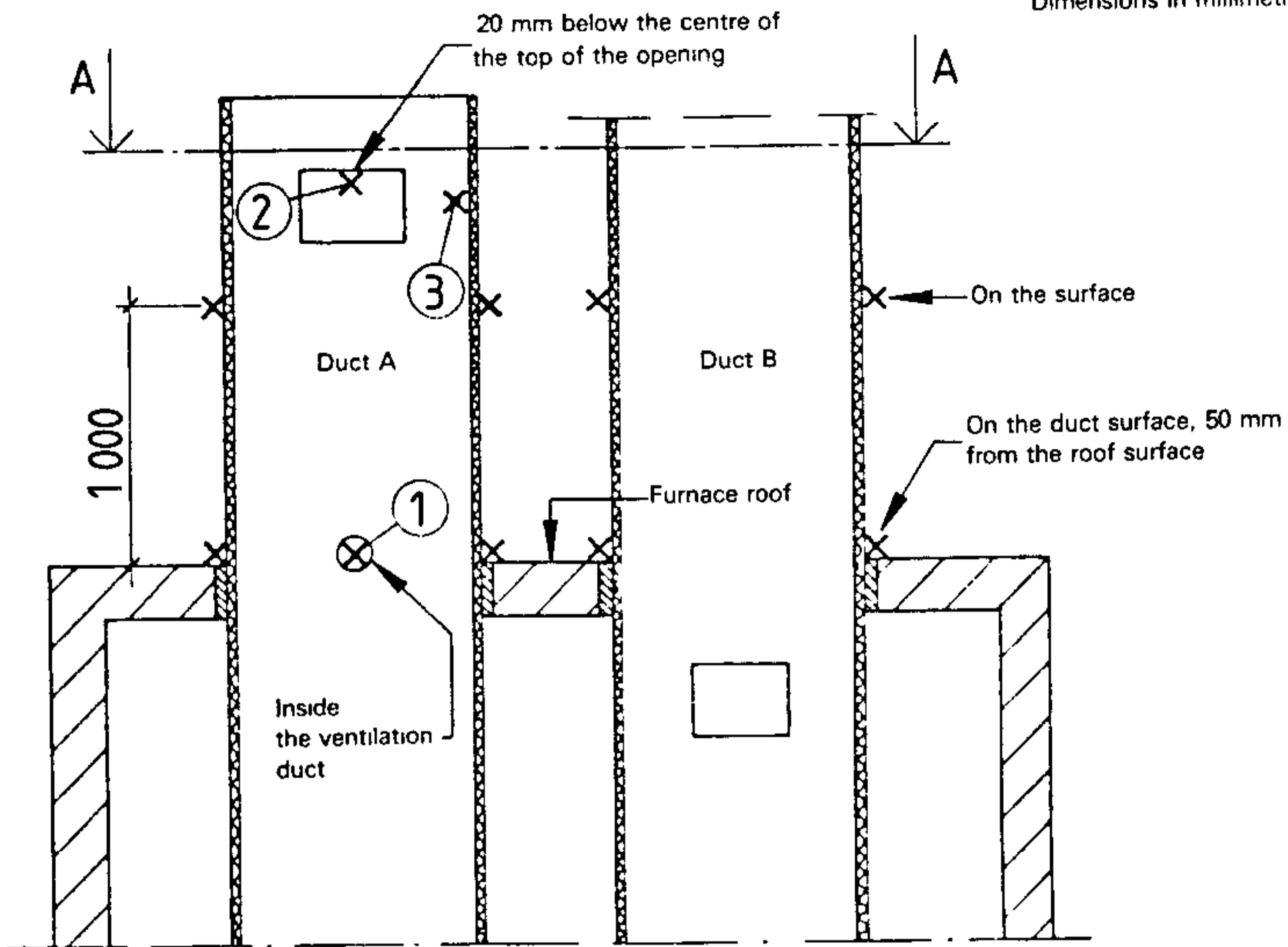

Figure 5 — Location of furnace thermocouples for ducts in horizontal position (see also figure 2)

Dimensions in millimetres



X = Thermocouples

⊗ = Thermocouples inside the duct

A-A

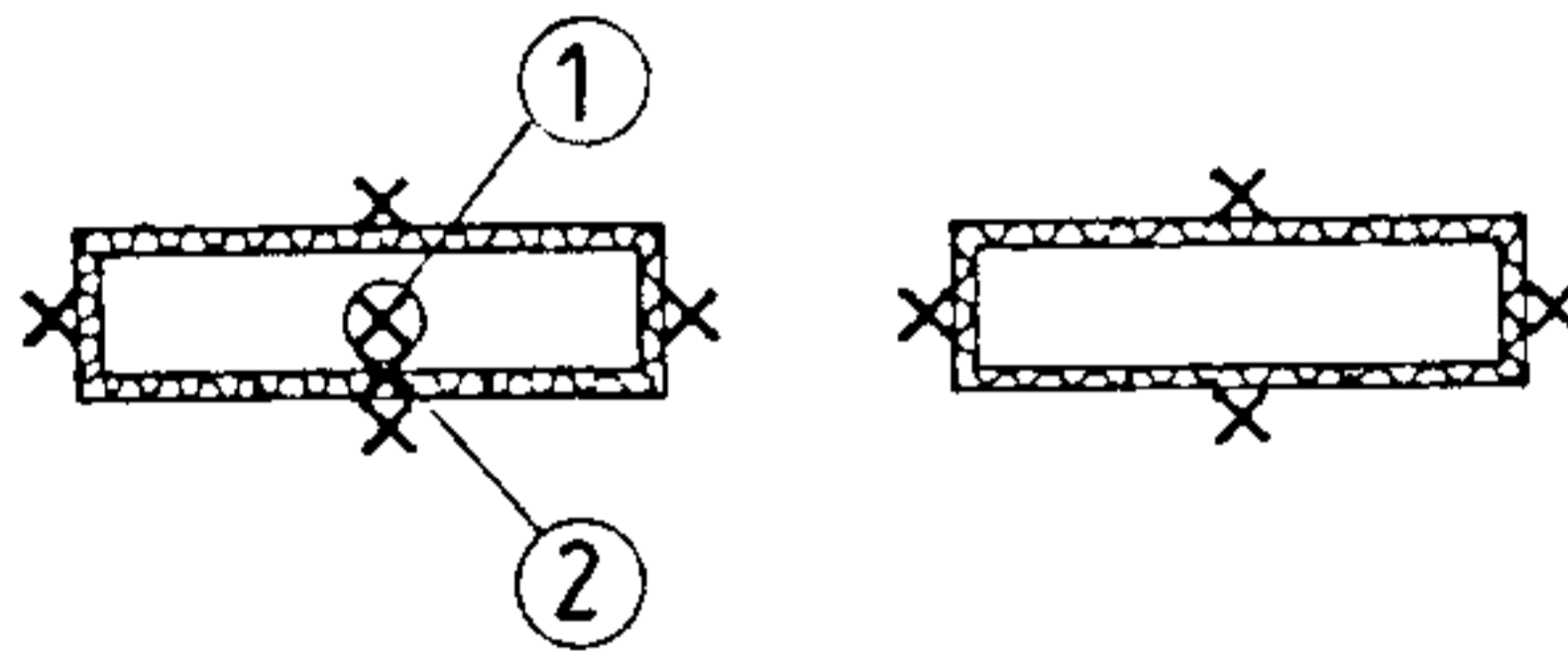

Alternative locations for assemblies of ducts

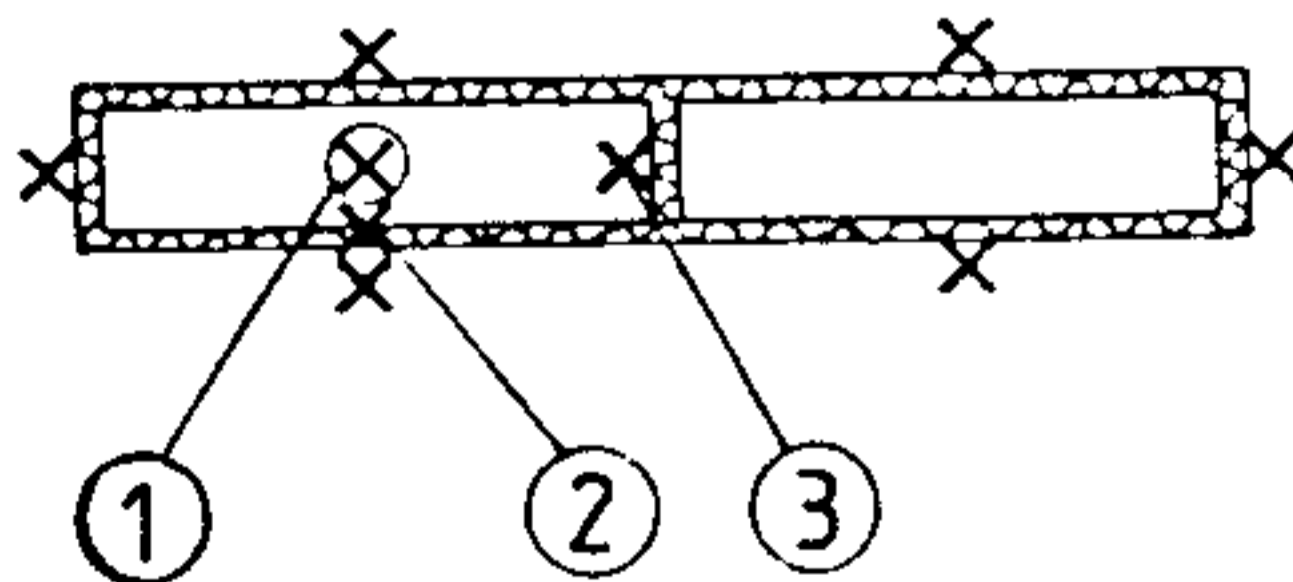

Figure 6 -- Location of thermocouples on vertical ducts outside the furnace (see also figure 1)

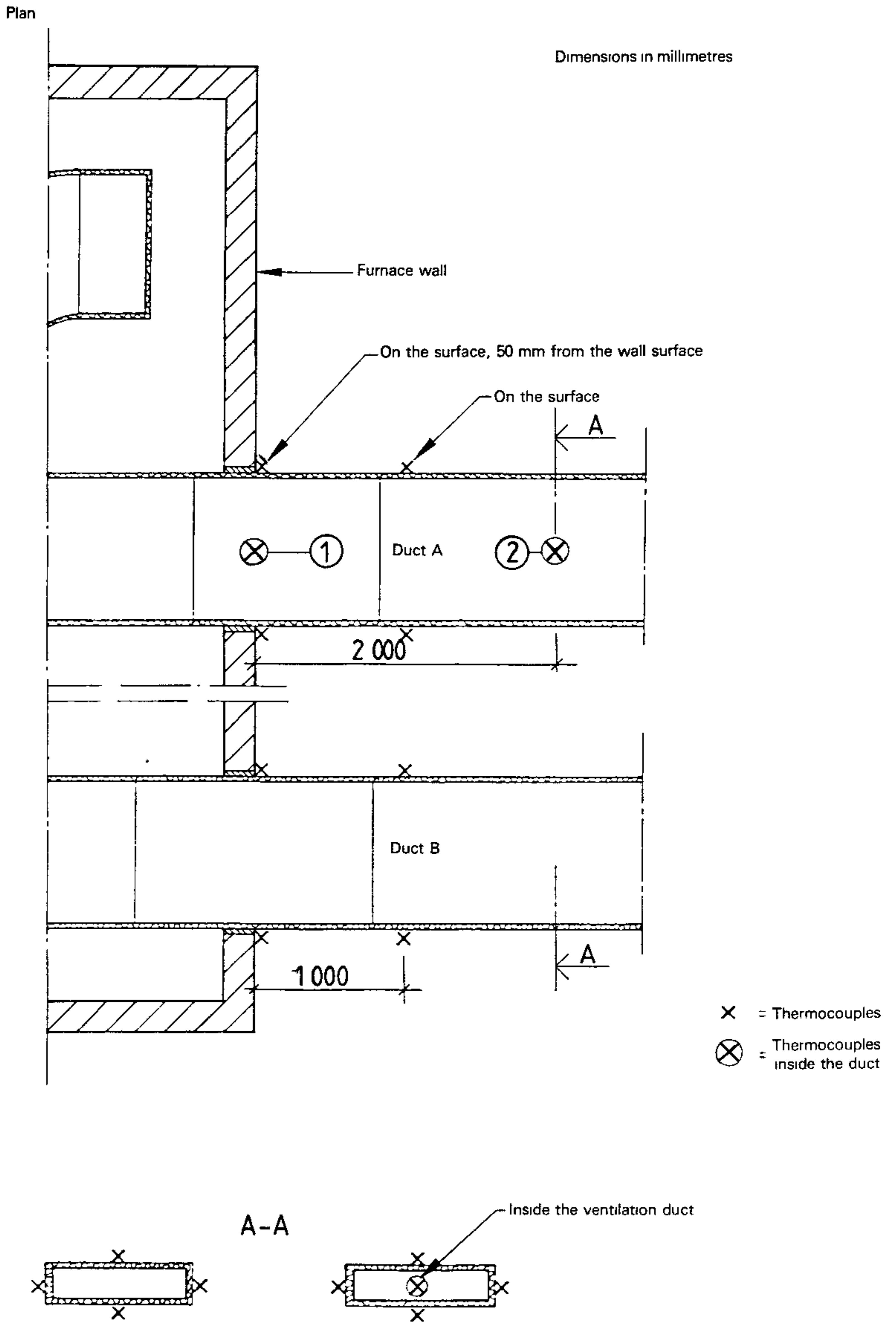

Figure 7 — Location of thermocouples on horizontal ducts outside the furnace

Dimensions in millimetres

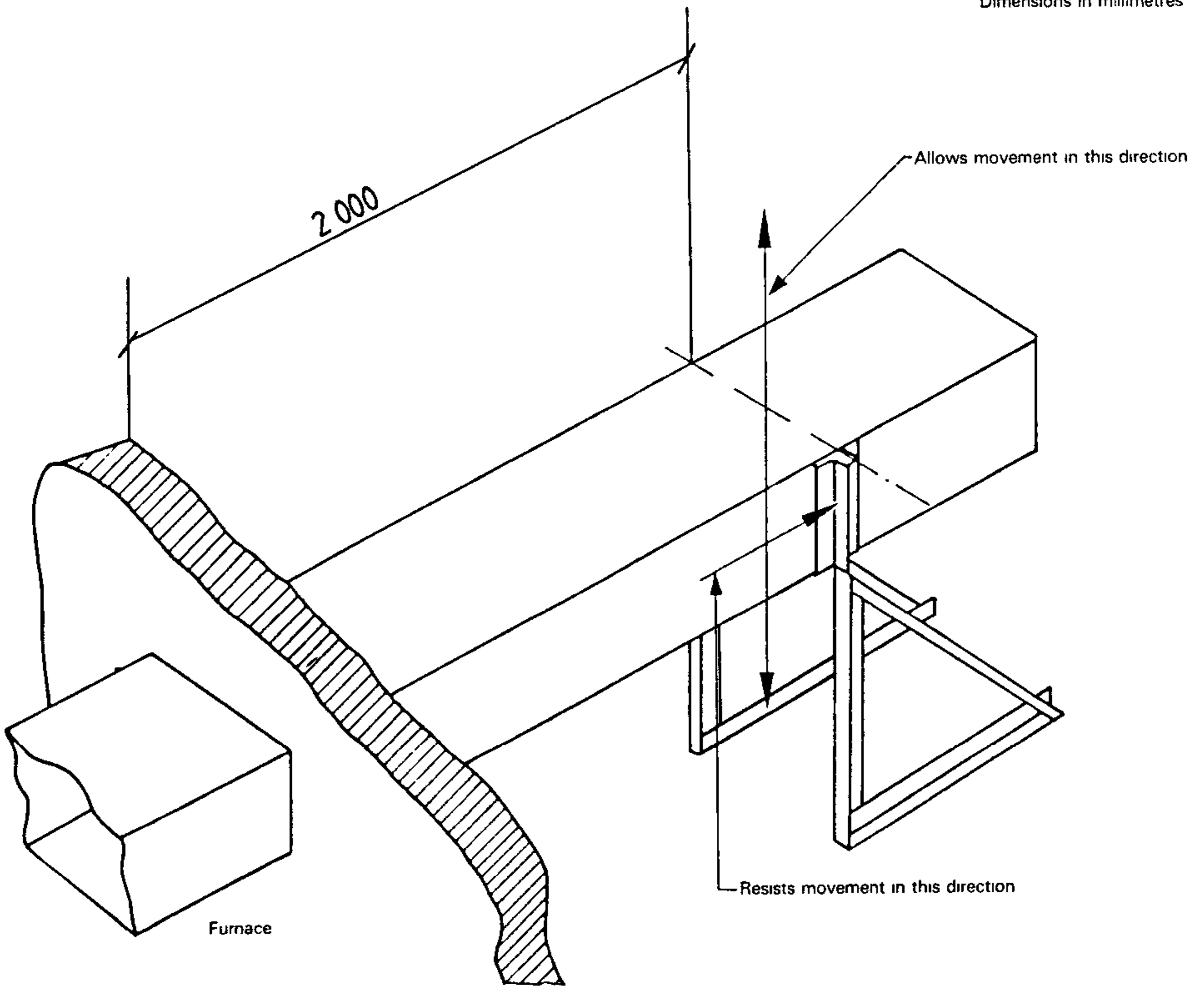

Figure 8 — Restraint of duct outside the furnace

Annex

Explanatory notes

(This annex does not form part of the standard)

A.0 General

The following explanatory notes are intended to serve as guidance for the planning, performance and reporting of a fire resistance test carried out in conformity with this International Standard.

A fundamental requirement for fire resistance tests is that the test results shall be reproducible. This requirement necessitates very accurate detailed specification of the test conditions, for the preparation of the test specimens and the characteristics of heating and restraint during the test.

Detailed data from a fire resistance test will also facilitate classification and the international utilization of the test data in countries with different classification requirements. For a satisfactory analysis of the test results, it may be necessary to complement a fire resistance test by other tests for the determination of the relevant properties of materials, for example thermal conductivity, specific heat, and strength and deformation properties in the temperature range associated with fires.

Since the duct, in practice, will be attached to fixed building members (floors, walls, etc), the anticipated effects of their expansion, contraction or deflection should be considered in a complete evaluation of fire performance

It may also be necessary to carry out additional tests of the load-bearing capacity and resistance to elongation or other deformation of hangers under fire conditions.

A.1 Notes on scope and field of application

Ventilation duct systems are well known for creating hazards by facilitating the spread of smoke and hot gases in the case of fire. Systems of this type are often complicated and extensive in modern buildings and their influence on the fire hazard has to be considered carefully. The fire hazard can be reduced either by providing fire dampers (tests on which are not covered by this International Standard) at the points where the ducts pass through fire separations, or by the provision of ducts which, themselves, are fire-resisting.

It is obvious that the impact of fire on a ventilation duct system, as well as the spread of fire through the system, can vary within a very wide range. A strict scientific approach to the problem of adequate testing of a ventilation duct would, therefore, be to design a series of tests each of which corresponds to a specified fire situation and duct arrangement. However, such an approach would probably fail due to its economic consequences, as tests of this type are very time-consuming and costly. The method of test described in this International Standard has therefore been designed with the intention of covering a wide range of fire situations in one single test corresponding to a "worst case" situation.

The worst case cannot be specified uniquely in every possible situation and it has, therefore, been necessary to accept some restrictions and lack of applicability of the method of test to all situations. The most important exclusion from the scope of this International Standard is an uninsulated ventilation duct located in the space immediately below the floor structure and protected against fire by a suspended ceiling of sufficient fire resistance, where other tests for the fire performance of the suspended ceiling may be used.

The method described in this International Standard is also not appropriate in the following contexts, unless the further criteria described are established to the satisfaction of the appropriate authority:

- a) A ventilation duct constructed of materials which are extremely sensitive to thermal shock, for the case when cold air passes through a fire compartment; the duct is thus attacked by fire from the outside whilst being cold on the inside. Here the thermal shock or other phenomena may cause the behaviour of the duct to be worse in practice than in the fire test, but if the sensitivity to shock is within agreed acceptable limits, the method of test described may still be used.
- b) Ventilation duct systems intended solely for the evacuation of smoke, which are intended to maintain their integrity and cross-sectional area within the fire compartment in order to enable the maximum quantity of smoke to be extracted throughout the fire period. In this case, any excessive leakage through the walls of the duct within the fire compartment (as well as outside it), and any restriction of the cross-sectional area of the duct due to twisting or buckling may impair the ability of the duct to extract the amount of smoke for which it was designed. It is considered that any restriction of the cross-sectional area of the duct to 75 % or less of its original area should be deemed to constitute failure in this case. It should be noted that, in practice, such ducts may cause movement of the smoke at higher velocities than in normal ventilation ducts (disregarding the noise). The high under-pressure in such situations may cause collapse of the duct.

c) Ducts lined on the inside with combustible materials or ducts, such as kitchen extract ducts, which are likely to accumulate combustible deposits. These may be tested in accordance with this International Standard if additional thermocouples are fixed at points on the inner surface of the duct within the furnace where hot spots are anticipated. Combustible linings (either external or internal) may be subject to certain requirements regarding spread of flame, fire propagation, etc. It has been found most convenient to exclude these properties from the test and to test them separately.

d) Special problems may occur when adjacent structural members (for example floors), from which horizontal ventilation ducts are suspended, deflect due to the thermal influence of the fire. The test results may then be difficult to interpret. The problem is of the same nature as mentioned in ISO 834 for non-load-bearing partitions and reference should, therefore, be made to the annex to ISO 834, A 6.1, note concerning 6.1.1.5.

Due to composite reactions caused by deflections of the ventilation duct and of the adjacent structural member, suspension and fastening devices, bolts, etc. may fail. However, it is emphasized that the method of test specified in this International Standard is not primarily intended to test such devices but the ventilation duct itself. Devices of this type should normally be evaluated separately. This means that failure of one or more fastening devices which are not specific to the particular duct assembly should not automatically be interpreted as a failure of the whole duct assembly.

e) In the case of a fire inside a horizontal duct (duct B in figure 2), duct hangers outside the furnace are liable to be attacked by the fire, for example where they cannot be well insulated on the side nearest to the duct. In this case a separate test, in addition to those mentioned in d) above, may be necessary on representative hangers, together with a section of the duct loaded as in practice.

A.2 Notes on principle

A.2.1 Smoke production

In 8.3.3, additional observations during the test, for example the emission of smoke or noxious fumes from the unexposed face of a duct, are required to be reported. This has been specified in order to facilitate the assessment of the overall fire hazard in a building.

As the combustion by the burners of the furnace does not produce visible smoke, and as it may be difficult to distinguish between smoke and any steam produced, the test gives no full and reliable indication of the quantity of smoke which could be passed by the duct from the burning room to other rooms of a building. The estimation of this has to be based on observations in accordance with 8.3.1.3.

In the case of ducts constructed of, or lined with, combustible materials, smoke can be produced by thermal decomposition of the duct or lining material and can enter other rooms. The estimation as to whether this represents a hazard depends on the amount and density of the smoke. A quantitative method of measuring this does not exist at present, but the following simple aid to assessment has proved to be suitable. This shall not, however, be allowed to interfere with measurements and observations required by this International Standard, such as observations of integrity failure.

A second room with the duct passing through it is constructed alongside or, as the case may be, on top of the furnace. The walls and the ceiling of this room can be constructed of simple light elements as the room is not heated by the burners. The room should be completely enclosed in order to collect the smoke which is emitted by the duct. From visual observation, the time can be established at which the density of smoke in the room is estimated to be such that it represents a danger for escaping persons. In order to have a common basis for this estimation the suggested dimensions of the room are 3,5 m × 3,5 m × 2 m. It can be assumed that an acceptable smoke level in a room of this size will be at least as acceptable in a larger room.

In relation to integrity it is recognized that the rise in temperature of thermocouple 1 at the furnace penetration points will only give a rough indication of integrity failure of ducts A, within the furnace, although it will give some indication of insulation failure within the furnace. The introduction of a tracer gas into the furnace and measurement of it within the duct may be a more precise method of measuring integrity failure. Also, the measurement and comparison of the amount of carbon dioxide within the furnace and within the duct may enable a rate of gas leakage to be ascertained.

Another method for estimating the leakage under fire conditions as an indication of integrity failure is the measurement of under-pressure in duct A; see 5.3.

A.3 Notes on apparatus

A.3.1 Reproducibility

At present, no information is available concerning the reproducibility of this method of test. In order to establish the reproducibility, calibration tests or round-robin tests will have to be performed.

A.3.2 Thermal elongation and shortening and restraint forces

During fire exposure, the ducts can expand or shrink due to high temperatures. This may cause premature failure of a non-load-bearing lightweight partition if the duct is fixed to it or butts against it. The expansion or shrinkage of the duct will apply a force to the partition.

Therefore, during tests, joints, attachment devices and a representative partition with fire-stopping are considered as being parts of the duct system being evaluated. Alternative joints, attachment devices, fire-stoppings, etc., should not be used unless it can be shown that the performance in respect to integrity and stability will not be worse and that the force on the partition resulting from expansion or shrinkage will not be greater.

As a consequence of the limitation of the force on a partition resulting from expansion, sliding fire-stopping devices are often chosen at the point of penetration through walls or partitions. Consequently, in this system, the installation of the duct must provide enough space and sufficiently flexible duct supports to allow for thermal elongation or shortening under fire conditions. The space required, based on the results of measurements of the elongation or shortening, shall be given in the test report.

In the case of horizontal ducts where the installation cannot ensure the required space for the elongation of the ducts or sufficient flexibility in the duct supports, a test with full restraint inside and outside the duct has to be performed if the laboratory cannot judge by experience that the restraint has no negative influence on the results. Duct B, in this case, should be fully restrained in the direction of the duct at the end inside the furnace and at a point 2 m outside the furnace, but there should be no restraint in a vertical direction. This will represent the "worst case" condition where, for example, a duct butts against a corridor a short distance away from the fire compartment, or where the "cold" portions of the duct system outside the fire compartment act as a rigid restraint to the expansion forces. A suitable method of restraining the duct specimen outside the furnace is shown in figure 8.

If applicable, details of the arrangement for measuring the restraint force at the penetration point are given in figure 3.

A.4 Notes on test conditions

A.4.1 Temperature-time development

If the ventilation ducts are assumed to be subjected to a fully developed fire, the temperature-time curve according to ISO 834 is chosen. Other fire curves could be discussed, but their scientific background has been found insufficient to permit an alternative proposal.

A.4.2 Anticipated pressure ranges

The movement of air in a duct passing through a compartment on fire, and which has no openings to that compartment, may create an underpressure on the duct walls which may encourage the fire to exploit any cracks which develop in the duct. An underpressure of 300 ± 10 Pa in horizontal duct A has been chosen as being realistic in this "worst case" situation and is the underpressure at which any integrity failure of the specimen within the furnace shall be measured.

A.4.3 Measurements of temperature of test specimens

The temperature measurements are assumed to be carried out as specified in the relevant clauses of ISO 834, with additional measurements being necessary because of the special nature of the test specimens. In particular, an additional temperature measurement is specified for the separating wall between two ducts built together, one of which is carrying fire gases. It has tentatively been proposed that 300 °C should be the maximum acceptable temperature on the unexposed side of such a separating wall.

A.5 Notes on preparation of test specimens

The test specimen shall be representative of duct installations in practice. This implies that joints, suspension and fixing devices, bolts, etc., shall be included and mounted in accordance with the manufacturer's mounting instructions. The distance separating joints and the span between supports should be sufficient to enable interpolation within a range of other lesser dimensions to be made. In some situations, the furnace may be too small to reproduce a relevant fire exposure in a particular duct assembly. This implies that the duct assembly to be used in practice may need to be modified in order to fit it into the furnace.

In most cases, the largest ducts likely to be used and which can be accommodated in the furnace whilst maintaining the specified velocity in the duct (i.e. 3 m/s) shall be tested. Unjustifiable extrapolation to ducts restrained in a different manner, supported at greater intervals or of a larger size, should not be made. Care should be taken when making any assessment of the performance of ducts which do not entirely conform in practice with the conditions represented in the test.

Distortion of rectangular ducts is generally more severe than distortion of square or round ducts. Hence, the maximum width to height ratio intended for use shall be tested. In other cases, or if the ratio is not specified, the test specimens should have walls with a ratio of 1/4, the longest side being 1 m if possible. The longest side of the horizontal specimen should normally be orientated horizontally in the furnace.

This International Standard requires the testing of a minimum length of 3,0 m for horizontal ducts and 2,0 m for vertical ducts inside the furnace and 2,5 m and 2,0 m, respectively, outside the furnace. These lengths have been chosen in order to use the fire test furnaces available in most countries. Some laboratories have larger furnaces and can consequently test larger or longer test specimens: this is most desirable. In some cases, they can obtain more comprehensive results from the tests.

A.6 Notes on test arrangements

For the safety of personnel, all heated gases exhausted from the ducts being tested should be directed outside the test laboratory.

A.7 Notes on procedure

A.7.1 Insulation and integrity

The procedure includes periods during which the fans are running, interrupted by periods when the fans are stopped. This regime is used to enable a check of the insulation and integrity properties to be made in various typical circumstances, but it is not representative of conditions in practice as far as one duct is concerned.

Assuming cut-out of the ventilating fan in the event of a fire, the temperature of the gases within an insulated duct, exposed on the exterior to fire conditions, will rise both due to heat transfer through the duct wall and due to any failure in integrity.

A measure of the likely temperature of gases diffusing through the system away from the fire compartment may be obtained from thermocouple 2, reading the gas temperature within duct A in figures 6 and 7. The temperature of gases at this point is not considered as a failure criterion, because the significance of the temperature and what the maximum permissible temperature should be at this point would depend on the proximity of combustible material and the presence of air grilles. This temperature should, however, be recorded because there is, in practice, the risk of fire gases penetrating into an adjacent compartment, depending on the pressure difference. If an opening into the system is sited close to a fire separating wall, then appropriate protection against the diffusion of hot gases into the compartment should be provided.

Some countries may wish to specify the size of cracks, holes or other openings outside the furnace which shall constitute integrity failure.

In the event of a fan continuing to operate, the overpressure from a supply fan will normally exceed the buoyancy pressure of the fire, preventing fire gases entering the system, any negative pressure differential maintained by an extraction fan will only serve to assist the evacuation of hot gases to the atmosphere.

A.7.2 Stability

The criterion for stability failure is only relevant inside the furnace for ducts A, and not for ducts B. Outside the furnace, however, both ducts A and B are subject to the criterion for stability failure. Any collapse or failure of fixing devices, etc., in respect of ducts B within the furnace should, nevertheless, be reported under 8.3.3.

A.8 Notes on failure criteria

The importance of the various failure criteria of stability, integrity and insulation may vary according to whether the duct is a normal ventilation duct, a "smoke outlet" duct or a "kitchen extract" duct as described above. For convenience of reference to appropriate items in this International Standard, the failure criteria are analysed in the following summary table, with an indication given as to the status of each particular case. The footnotes to the table indicate other tests and measurements which may be required.

Table — Fire resistance test on ventilation ducts — Necessary measurements

Key M = mandatory
 NM = not mandatory
 N/A = not applicable

Type of duct		Stability		Integrity		Insulation			
Vertical		Collapse within or outside furnace (see A 7 2)	Loss of shape (reduction to 75 % of cross-sectional area) (not mandatory (see A 1 b))	Sustained flaming or gaps outside furnace (see 7 2 and A 7 1)	Air temperature inside duct outside furnace (thermo-couple 2) (see A 7 1)	Mean temperature rise over 140 °C on surface outside furnace	Temperature rise over 180 °C of any "hot spot" on surface outside furnace	Mean temperature rise over 140 °C on surface inside duct	Temperature rise over 180 °C of any "hot spot" of surface inside duct
Fire outside duct (duct A)	Normal ducts No fan (see A 7 1)	M	N/A	M	M	M	M	N/A	N/A
	Smoke outlet ducts [see A 1 b]) No fan (see A 7 1)	M	M	M	M	M	M	N/A	N/A
	Kitchen extract ducts or ducts containing combustible linings [see A 1 c]) No fan (see A 7 1)	M	N/A	M	M	M	M	M	M
Fire inside duct (duct B)	Normal ducts Fan on (see A 7.1)	M outside furnace N/A inside furnace	N/A	M	N/A	M	M	N/A	N/A
	Fan off (see A 7 1)	M outside furnace N/A inside furnace	N/A	M	N/A	M	M	N/A	N/A
	Smoke outlet ducts [see A 1 b]) Fan on (see A 7 1)	M outside furnace N/A inside furnace	M	M	N/A	M	M	N/A	N/A
	Fan off (see A 7.1)	M outside furnace N/A inside furnace	M	M	N/A	M	M	N/A	N/A
	Kitchen extract ducts or ducts containing combustible linings [see A 1 c]) Fan on (see A 7 1)	M outside furnace N/A inside furnace	N/A	M	N/A	M	M	N/A	N/A
	Fan off (see A 7 1)	M outside furnace N/A inside furnace	N/A	M	N/A	M	M	N/A	N/A

Table — Fire resistance test on ventilation ducts — Necessary measurements (*concluded*)

Type of duct		Stability		Integrity		Insulation			
		Collapse within or outside furnace (see A 7 2)	Loss of shape (reduction to 75 % of cross-sectional area) [not mandatory (see A 1 b)]	Sustained flaming or gaps outside furnace (see 7 2 and A 7 1)	Air temperature inside duct outside furnace (thermo-couple 2) (see A 7 1)	Mean temperature rise over 140 °C on surface outside furnace	Temperature rise over 180 °C of any "hot spot" on surface outside furnace	Mean temperature rise over 140 °C on surface inside duct	Temperature rise over 180 °C of any "hot spot" of surface inside duct
Fire outside duct (duct A)	Normal ducts Fan on (see A.7 1)	M	N/A	M	NM	M	M	NM	M
	Smoke outlet ducts [see A 1 b] Fan on (see A 7 1)	M	M	M	NM	M	M	NM	M
	Kitchen extract ducts or ducts containing combustible linings [see A 1 c] Fan on (see A 7 1)	M	N/A	M	NM	M	M	M	M
Fire inside duct (duct B)	Normal ducts Fan on (see A 7 1)	M outside furnace N/A inside furnace	N/A	M	N/A	M	M	N/A	N/A
	Fan off (see A 7 1)	M outside furnace N/A inside furnace	N/A	M	N/A	M	M	N/A	N/A
	Smoke outlet ducts [see A 1 b] Fan on (see A 7 1)	M outside furnace N/A inside furnace	M	M	N/A	M	M	N/A	N/A
	Fan off (see A 7.1)	M outside furnace N/A inside furnace	M	M	N/A	M	M	N/A	N/A
	Kitchen extract ducts or ducts containing combustible linings [see A 1 c] Fan on (see A 7.1)	M outside furnace N/A inside furnace	N/A	M	N/A	M	M	N/A	N/A
	Fan off (see A 7 1)	M outside furnace N/A inside furnace	N/A	M	N/A	M	M	N/A	N/A

NOTES

- 1 Additional tests may be carried out to evaluate suspension and fastening devices [see A.1 d) and e)].
- 2 Measurements (non-mandatory) may also be made and criteria established by the relevant authorities in respect of
 - a) the temperature of the unexposed surface of the dividing wall between an assembly of vertical ducts, 300 °C being the suggested failure criterion (see A 4 and figure 6);
 - b) sensitivity to thermal shock [see 1 5 a)];
 - c) gas leakage rates [see 3 3 a)];
 - d) smoke production [see 3.3 b) and A 2 1],
 - e) elongation or shortening of the specimen (see 8.3.2 and A. 3.2);
 - f) restraint forces (see 8.3.2 and A.3 2).

Publication referred to

See national foreword.

BS 476 : Part 24 : 1987 ISO 6944-1985

This British Standard, having been prepared under the direction of the Fire Standards Committee, was published under the authority of the Board of BSI and comes into effect on 29 May 1987

© British Standards Institution, 1987

ISBN 0 580 15865 9

British Standards Institution

Incorporated by Royal Charter, BSI is the independent national body for the preparation of British Standards. It is the UK member of the International Organization for Standardization and UK sponsor of the British National Committee of the International Electrotechnical Commission.

Beyond the production of standards, BSI offers specialist services including the provision of information through the BSI Library and Standardline Database, Technical Help to Exporters, and other services. Advice can be obtained from the Enquiry Section, BSI, Milton Keynes MK14 6LE, Telephone 0908 320066

Copyright

Users of British Standards are reminded that copyright subsists in all BSI publications. No part of this publication may be reproduced in any form without the prior permission in writing of BSI. This does not preclude the free use, in the course of implementing the standard, of necessary details such as symbols and size, type or

grade designations. Enquiries should be addressed to the Publications Manager, British Standards Institution, Linford Wood, Milton Keynes MK14 6LE. The number for telephone enquiries is 0908 320033 and for telex 825777.

Contract requirements

A British Standard does not purport to include all the necessary provisions of a contract. Users of British Standards are responsible for their correct application.

Revision of British Standards

British Standards are revised, when necessary, by the issue either of amendments or of revised editions. It is important that users of British Standards should ascertain that they are in possession of the latest amendments or editions. Information on all BSI publications is in the *BSI Catalogue*, supplemented each month by *BSI News* which is available to subscribing members of the Institution and gives details of new publications, revisions, amendments and withdrawn standards. Any person who, when making use of a British Standard, encounters an inaccuracy or ambiguity, is requested to notify BSI without delay in order that the matter may be investigated and appropriate action taken.

The following BSI references relate to the work on this standard
Committee reference FSM/1 Draft for comment 84/37753 DC

Committees responsible for this British Standard

The preparation of this British Standard was entrusted by the Fire Standards Committee (FSM/-) to Technical Committee FSM/1, upon which the following bodies were represented

Association of British Roofing Felt Manufacturers
Association of Building Component Manufacturers Ltd
Association of Structural Fire Protection Contractors and Manufacturers
British Coal
British Fire Services' Association
British Floor Covering Manufacturers' Association
British Plastics Federation
British Railways Board
British Rigid Urethane Foam Manufacturers' Association
British Wood Preserving Association
Cement and Concrete Association
Chemical Industries Association
Chief and Assistant Chief Fire Officers Association
Concrete Society
Department of Education and Science
Department of the Environment for Northern Ireland
Department of the Environment (Housing and Construction Industries)
Department of the Environment (Property Services Agency)
Department of Transport (Marine Directorate)
Electricity Supply Industry in England and Wales
Engineering Equipment and Materials Users' Association
Eurisol (UK) Association of Manufacturers of Mineral Insulation Fibres
Fibre Building Board Organisation (FIDOR)
Fibre Cement Manufacturers Association Limited
Fire Insurers Research and Testing Organisation (FIRTO)
Fire Offices Committee
Fire Protection Association

Flat Glass Manufacturers' Association
Flat Roofing Contractors' Advisory Board
Gypsum Products Development Association
Home Office
Institution of Fire Engineers
Mastic Asphalt Council and Employers' Federation
National Council of Building Materials Producers
National GRP Construction Federation
RAPRA Technology Ltd
Royal Institute of British Architects
Steel Construction Institute
Timber Research and Development Association
United Kingdom Antimony Oxide Manufacturers' Association
United Kingdom Atomic Energy Authority
Warrington Fire Research Centre
Wood Wool Slab Manufacturers' Association
Yarsley Technical Centre Ltd.

The following bodies were also represented in the drafting of the standard, through subcommittees and panels:

Association of Builders Hardware Manufacturers
British Steel Industry
Department of the Environment (Building Research Establishment, Fire Research Station)
Door and Shutter Association
Electric Cable Makers' Confederation
Guild of Architectural Ironmongers
Hevac Association
Intumescent Fire Seals Association
National Association of Lift Makers
Suspended Ceilings Association
Thermal Insulation Manufacturers' and Suppliers' Association (TIMSA)

Amendments issued since publication

Amd. No.	Date of issue	Text affected

British Standards Institution · 2 Park Street London W1A 2BS · Telephone 01-629 9000 · Telex 266933